

Check list for package reception

Suivi des évolutions

Indice	Date	Description de l'évolution	Auteur
0.0	15/01/2022	Création	FBR

Rédacteur	Responsable X	Qualité
FBR	FBR	FBR

Intro

This document aim to check the kit received by customer, or for people to check their own printed parts

It can happen that part missed (rarely) into the package



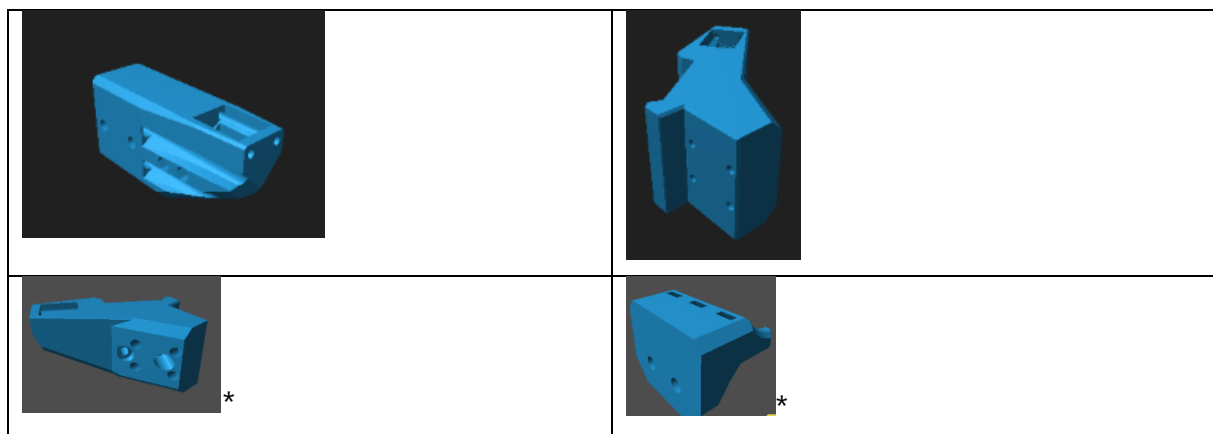

If part(s) is(are) missing at the package reception, please reach to contact@brs-engineering.com or Florent Broise on Facebook, missing part will be shipped ASAP to you

1-Vcore Kit (original stock Z)



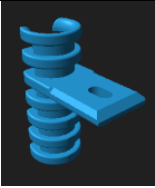
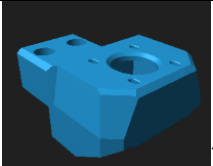
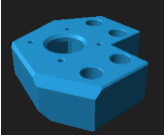
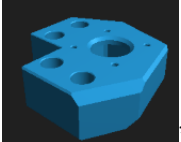
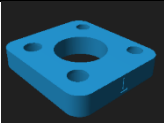
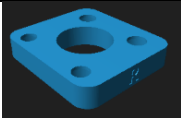

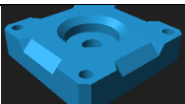
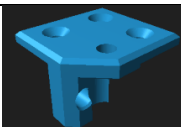
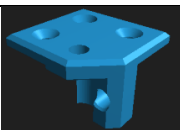
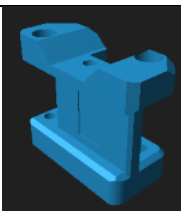
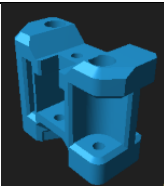
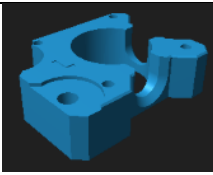
Check list

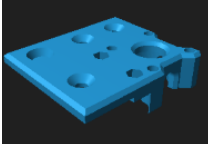
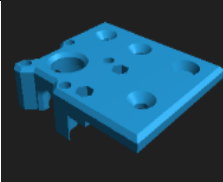
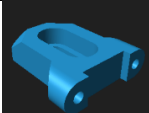
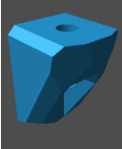
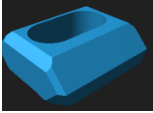
			*
	*		*
			
	*		*
	*		*
	*		*
	*		*
	*		*
	*		*
	*		*



2-Z-upgrade kit







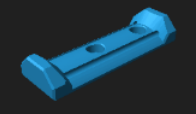
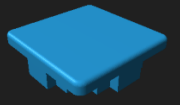
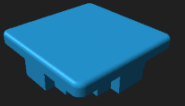
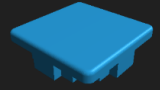





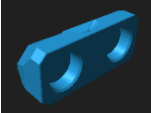

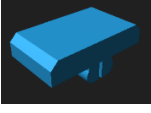
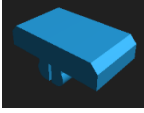

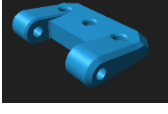
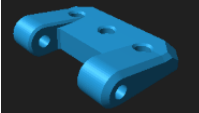
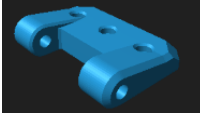
3-EVA Parts :

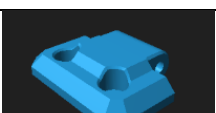
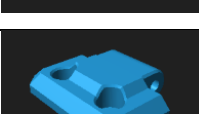

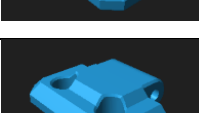
Will depends on your specific request, variations, option and additional parts asked





4-Enclosure option :

	
	
	
	
	
	
	
	
	
	<p>Electronic closing plates not included</p>

5-Wings : (assembled)

	
---	--

6-Oldham : (assembled)

